

PRESSURE PLATE
(MOVABLE)

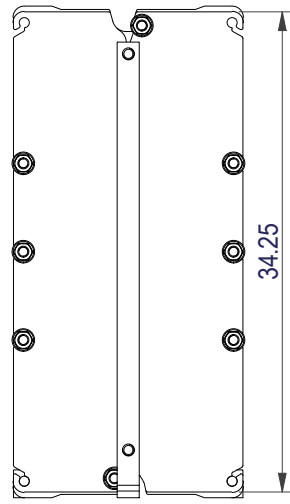

Space between pressure plate and supporting column should be kept free from fixed installations!

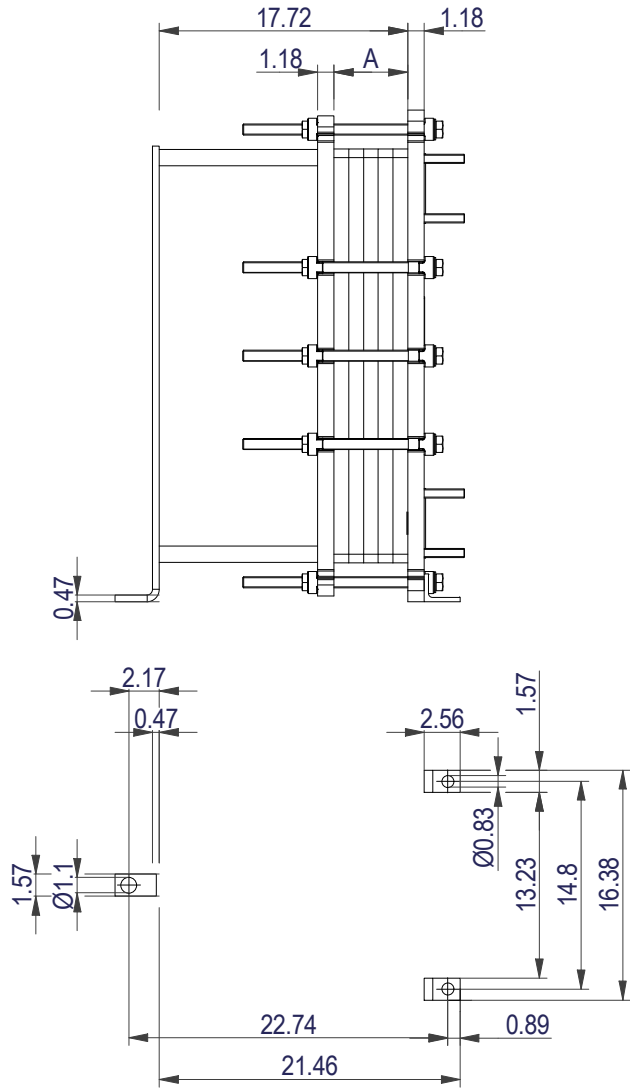

FRAME PLATE

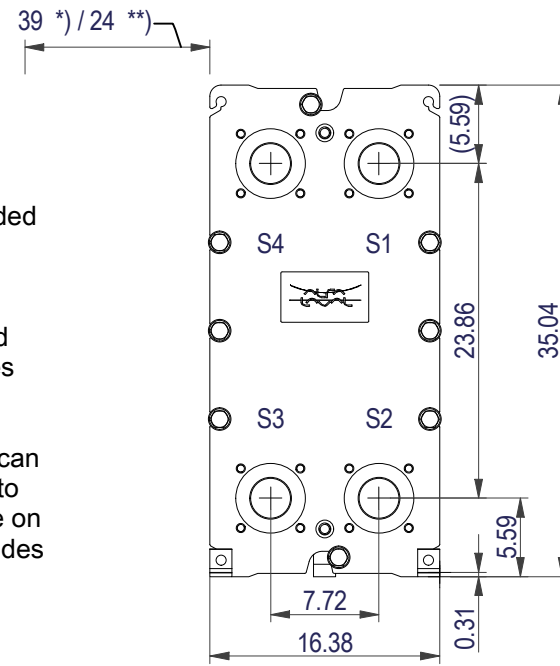

*) Recommended free space for opening and closing to be applied on both sides

**) Free space can be reduced to this distance on one of the sides

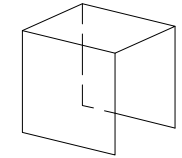
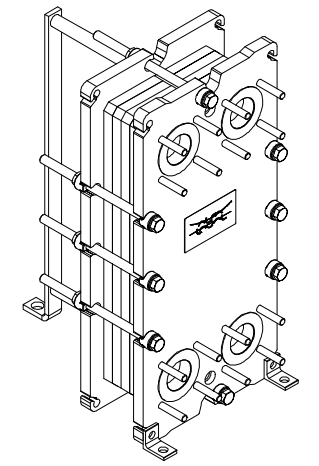

PROTECTION SHEET

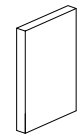

PRESSURE PLATE

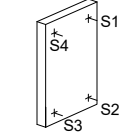

FRAME PLATE

ASME B16.5 Class 150 NPS 3

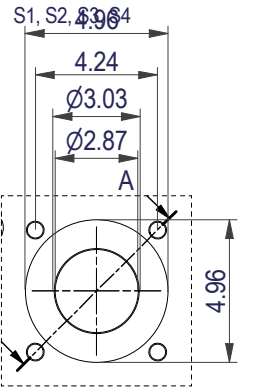

A-A:
ALLOY 316

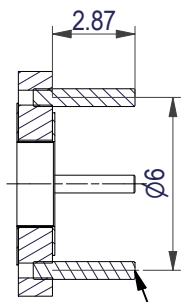

5/8"-11 UNC (x4)

TIGHTENING BOLTS 4 x M20, L = 13.0 in
4 x M20, L = 13.0 in

APPROX. OUTER DIMENSIONS
LENGTH 25.2 in
WIDTH 16.9 in
HEIGHT 35.4 in
APPROX. WEIGHTS
NET WEIGHT, EMPTY 433 lb
WEIGHT FULL OF WATER 463 lb
PLATE MATERIAL ALLOY 316
PLATE THICKNESS 0.5 mm
GASKET NBRP ClipGrip™

All dimensions in inches

HEAT EXCHANGED		3,010 kBtu/h		NO. OF UNITS		1		DESIGN PRESSURE		DESIGN TEMPERATURE		TEST	OPERATING
SIDE	MEDIA	INLET	TEMP.	OUTLET	TEMP.	FLOW RATE	PRES. DROP	MAX.	MIN.	MAX.	MIN.	PRESSURE	MAX. TEMP.
1		S1		S2				150 psi	0 psi	284 °F	32.0 °F	195 psi	
2		S3		S4				150 psi	0 psi	284 °F	32.0 °F	195 psi	



www.alfalaval.com

DRAWING
GASKETED PLATE HEAT EXCHANGER

T8-MFG

ASME
Code Section VIII Div.1

MAWP 150 psi at 284 °F
MDMT 32.0 °F at 150 psi
Designed and constructed in accordance with the 2019 ASME Code.

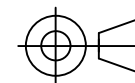

T8M 20 PL

Do not use this drawing for foundation bolting or piping layout

DATE 5/24/21
REVISION 0